

OTT

HYDROMETRIE

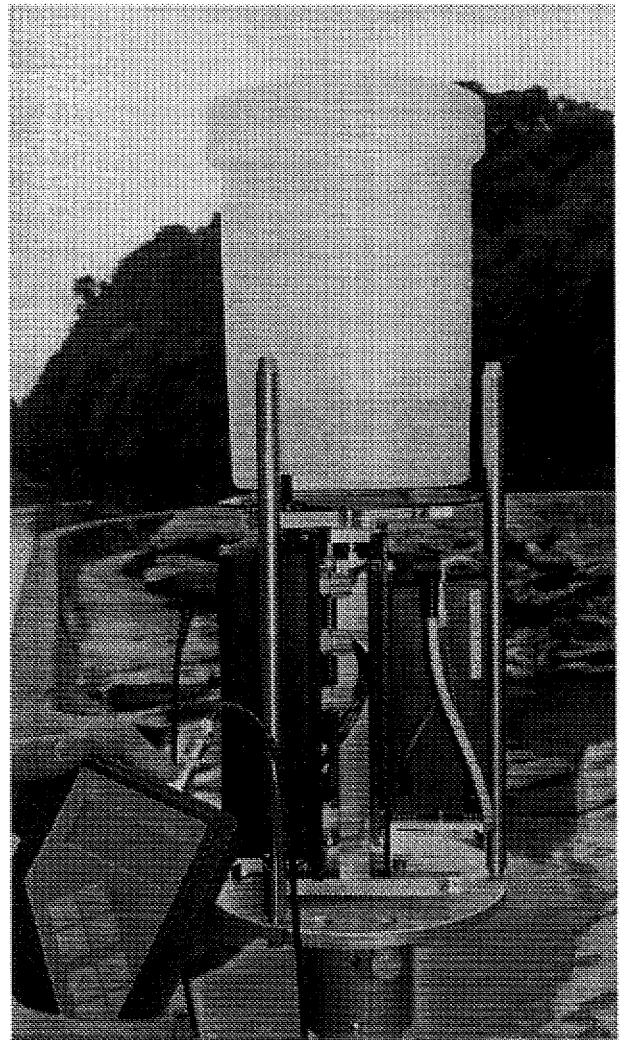

PLUVIO

Raingauge
– weighing princible –

70.010.000.B.E

Operating instructions

1.0	Description of the weighing system	2
2.0	Advantages over tipping bucket	3
3.0	Installation / Operational use	4-8
4.0	Designs	9
5.0	The PLUVIO standard device	10
5.1	Basic data-logging unit	10
5.2	Measured values	11
5.3	Time delay of precipitation intensity stored	12
5.4	Basic pulse-output unit	12
6.0	Power supply (changing the rechargeable battery)	13-14
7.0	Pin configuration in the case of external power supply	15-16
8.0	Data reading	17
8.1	Data reading with the HYDRAM II	17
9.0	Parameterization	18
10.0	OTT-LOG Pin configuration	19
	Overview: Parameterization with BG II Operating Unit or Notebook	20

1.0 Description of the weighing system

Unlike traditional measuring devices, this raingauge does not measure the volume of precipitation but its weight. Each precipitation event, whether liquid or solid precipitation, corresponds to an increase in the weight of the balance tank.

During every measurement, the sensor, an **electronic weighing cell**, measures the weight of the entire tank.

The sensor elements are wire resistance strain gauges that are hermetically shielded from any atmospheric influences, such as humidity, and thus long-time stability is guaranteed even when the raingauge is in use for several years.

A specially designed **link-joint element construction** assures the absolutely tension-free load transmission to the sensor. Even in the incidence of strong shearing forces by either wind or shock, proper operation of the weighing cell is assured.

The moving elements of the weighing system do **not cause any friction**, therefore they are resistant to pollution and hence they guarantee a long-term reproducible and maintenance-free operation.

A reliable **mechanic safety device** protects the weighing cell against overload. Moreover, a transport-safety device protects the sensor against damage during transport.

The integral **temperature compensation system** supplies an output signal that is independent of temperature.

Furthermore, **hardware and software filters** assure that the precipitation signal is not distorted by wind influences.

The **precision amplifier** and the high-resolution **analog to digital converter (ADC)** supply a digital output signal with a resolution of 25,000 parts. Given a measuring range of 250 mm (5 kg) this guarantees a resolution of **0.01 mm (0.2g)**.

The lock of the cylindrical stainless-steel housing is designed without any outside lock components. This is of particular advantage in the case of ice formation on the outer wall of the housing.

2.0 Advantages over tilting scales



By and large, the **housing dimensions** correspond to that of a Type Hellmann raingauge (WMO standard).

Owing to the weighing principle of the raingauge all **solid precipitation** can immediately be measured, it is **not necessary** to melt snow or hail by an electrical **heating device**. This is made possible by the fact that this system does not need a **collection funnel**. Beneath the defining ring of the measuring surface, liquid and solid precipitation alike directly get into the balance tank, thus evaporation losses within the funnel, which could for example be incurred in the case of slowly starting precipitation, are precluded.

Any **evaporation of precipitation** within the balance tank does not distort the measuring results since evaporation only starts after the precipitation and the data have already been gathered beforehand.

With this measuring method there are no **Intensity depending errors of measurement**, which can occur if tilting scales are used. All measuring devices are calibrated prior to delivery, that means that all devices have the same output signal. Customised, device-specific error correction within the data logging system is not required.

This is of particular advantage in the case of large measuring fields with centralised data logging.

No heating is required when **operating the system in winter** since there are no water-bearing tubes. The measuring signal is not influenced in any way if the contents of the balancing tank freeze. Moreover the balance tank is fracture-proof down to a temperature of -30°C . Therefore, the system can be **powered by rechargeable batteries** even in winter and evaporation losses during heating phases are of no account.

This precipitation-gauging method requires the balance tank to be **emptied manually**.

Maintenance is limited to the evacuation of the balance tank, the recharge of the batteries and the evaluation of the data logger (if applicable). From time to time, the careful **visual inspection of all powered mechanical components** is required since the reproducibility of the measuring signal can be influenced by the presence of reptiles or spiders.

The weighing mechanism was designed in a way so that no friction-causing link-joint elements had to be used. These neurlgic points therefore do not require cleaning.

Pollution or contamination of the balance tank, e.g. by leaves or bird droppings, initially distort the measuring results achieved with the weighing method. They, however, do not lead to a total breakdown or the distortion of subsequent measurements. During evaluation, the measured values can be corrected afterwards on the basis of the previously stored data.

With the weighing system it is possible to determine the amount of **evaporation** after the individual precipitation events. However, the special climatic conditions that prevail within the PLUVIO housing (wind, temperature and humidity) require a lot of experience so as to enable the user to infer evaporation in the open from the evaporation conditions prevalent within the housing. Output of data showing the intensity of evaporation is being prepared.

3.0 Installation / Operational use

Before you unpack the PLUVIO rain gauge please carefully check the cardboard box for any visible outside damage.

Open the cardboard box and, after visual inspection of the device, transport the rain gauge to the desired location keeping it upright.

→ Please do not expose to shocks.

For the installation of the rain gauge the stainless-steel housing has to be removed. Untie the cable lacing tape and then carefully remove the housing by lifting it upward.

The device can be mounted onto 2" stand tubes with the attachment flange situated on the bottom side of the PLUVIO rain gauge.

Diameter: 2" (60 mm \pm 5 mm),
Length: 800 mm
Height: 430 mm above ground level if
the installation level is 1m

Assure that the stand tube is in a stable, vertical position. → Encase the tube with concrete. For devices with external power supply or connection to a CAN field bus an empty tube can be provided so as to facilitate proper cable laying.

The PLUVIO can be fixed provisionally with the upper Allen screw on the attachment flange. Please carefully tighten the screws alternately and in a clockwise direction until they all evenly touch the wall of the stand tube.

Determination of the perpendicular orientation of the PLUVIO rain gauge is facilitated by the water level (bubble level) integrated on the upper side of the base plate.

The lower Allen screws are used for the precise adjustment of the PLUVIO. The rain gauge is oriented horizontally when the level bubble is in the centre of the inspection glass (cf. figure on p. 5).

The rain gauge's ideal position can be found by means of the three lower Allen screws. When the screw is screwed in, the air bubble wanders in the direction of the screw position. As soon as the air bubble is located within the inner circle of the bubble level → drive the fastening screws home.



Apart from the transport-safety device (cf. p. 6) no further screws or other fasteners have to be loosened or removed for mounting and operating the raingauge.

Alignment of the bubble level

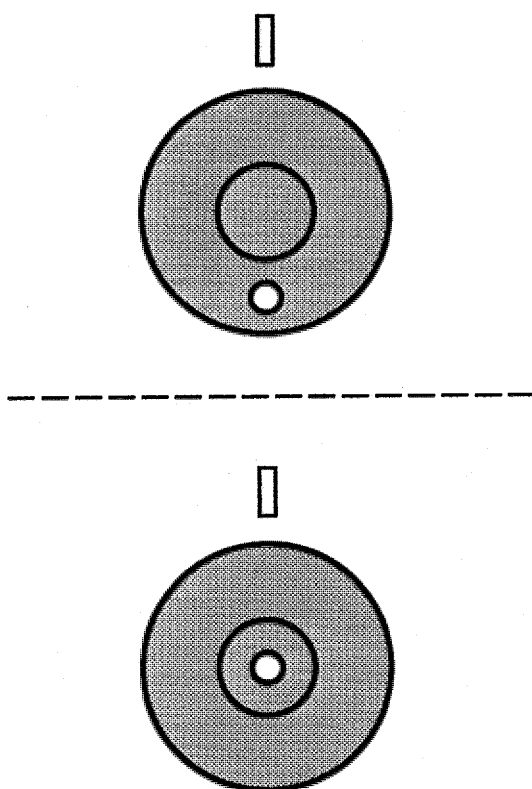

After having adjusted the raingauge please drive the upper fastening screws home once again and make sure that the PLUVIO is mounted correctly.

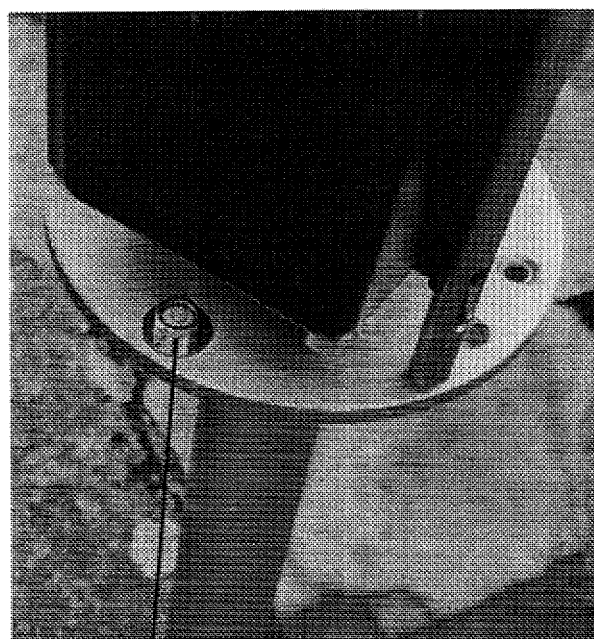
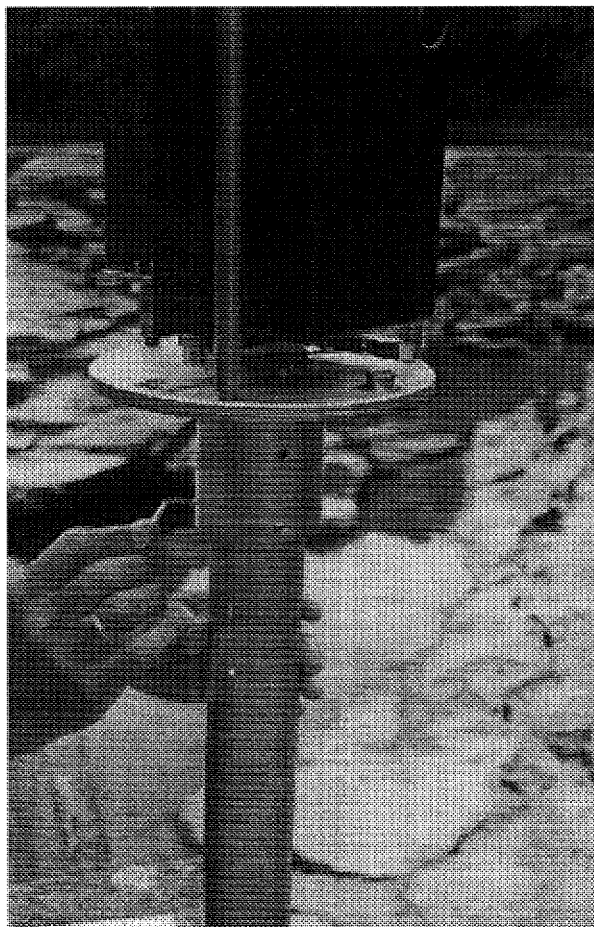

bubble level

Installation / Operational use

After having mounted the PLUVIO raingauge please remove the transport-safety device (cf. picture on the right).

The transport-safety device is located on top of the black base plate of the balance tank.

Unscrew the cylindrical plastic component and screw it onto the headless setscrew next to the OTT type plate to keep it there for future transports.

When re-activating the transport-safety device, screw the above-mentioned plastic component through the base plate onto the headless setscrew and **carefully** drive it home → do not use force.

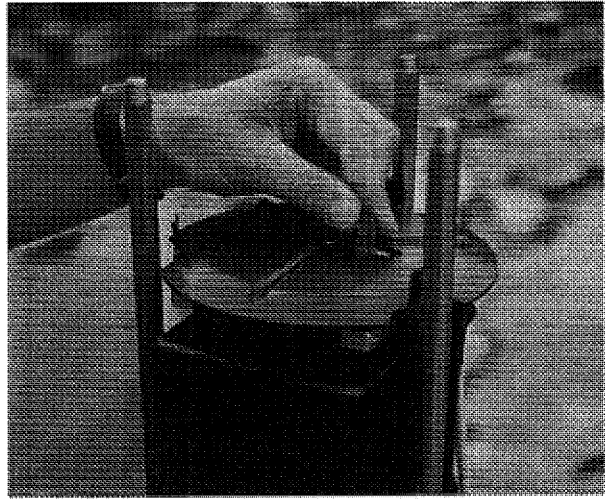

Do not hold the raingauge on the black weighing plate when transporting it! Make sure that the motion rods are seated firmly!

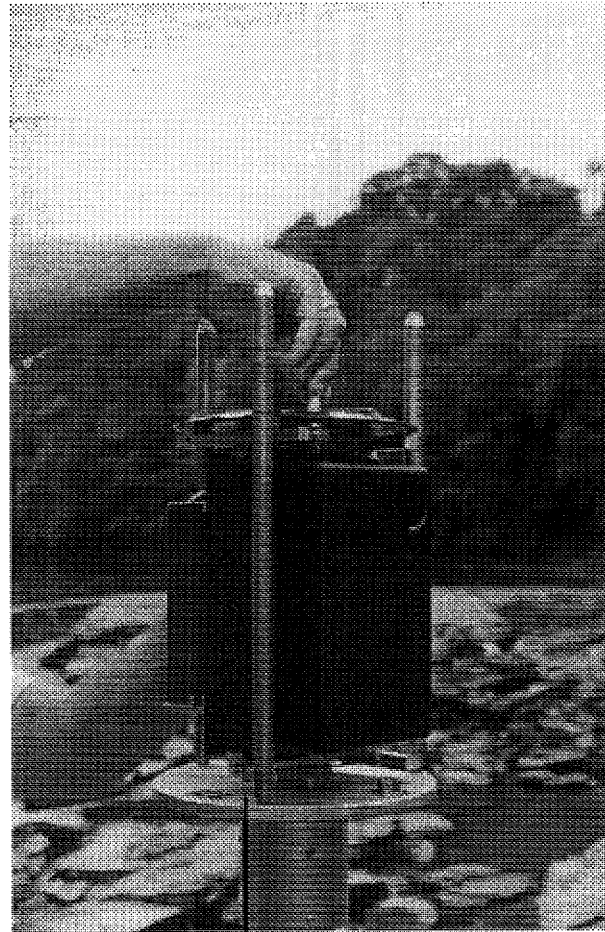

Seat of the transport-safety locking pin (for preservation).

Place the balance tank onto the base plate.

Move the stainless-steel cylinder down over the balance tank and the motion rods and lower it until it fully covers the base plate.

The switching contact (microswitch) is actuated. When the switching contact is not actuated, no data storage will take place. The electric switch is designed as a break contact. The measuring operation will be resumed after actuation of the contact (with mounted protective housing) and after four query intervals have elapsed.

Turn the protective cylinder so that the die heads on the protective cylinder's outer wall coincide with the motion rods (use Allen screws on the bottom side as guideline - cf. figure).

→ Arrest the cylinder by turning it to the right.

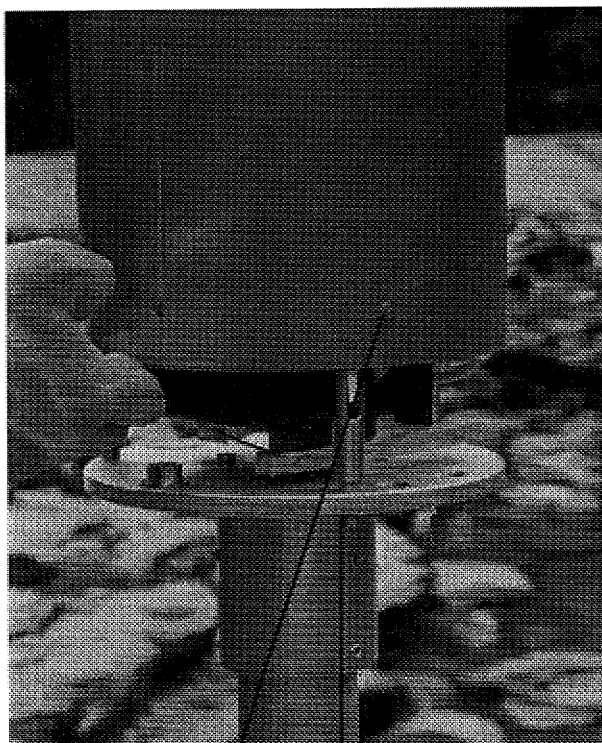
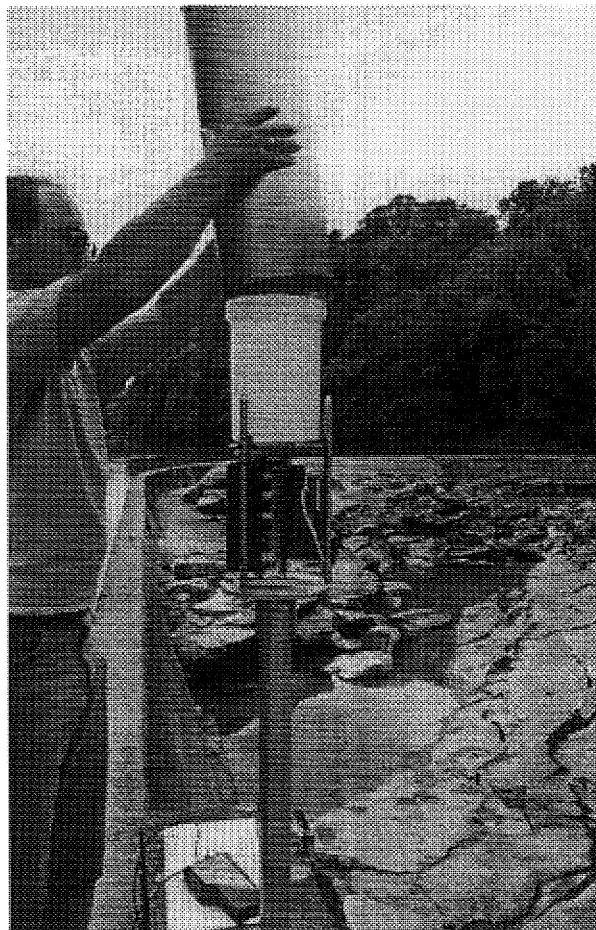

Die head

Allen screw

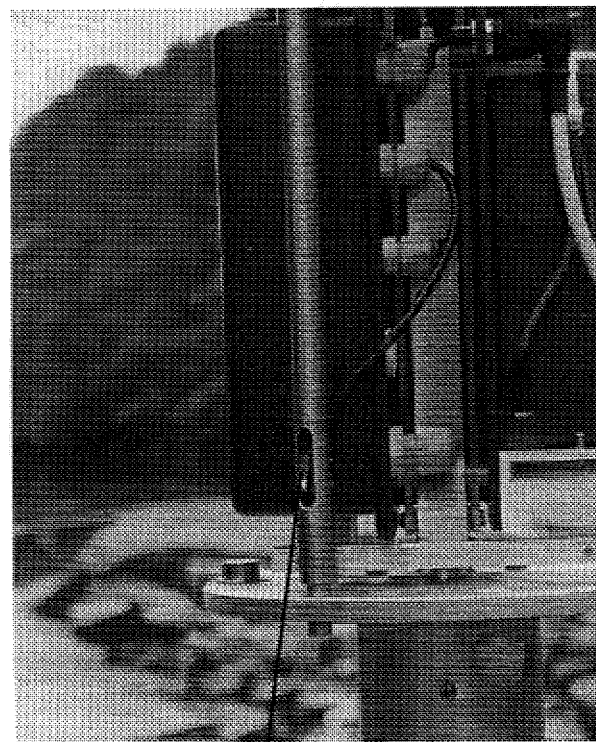

microswitch

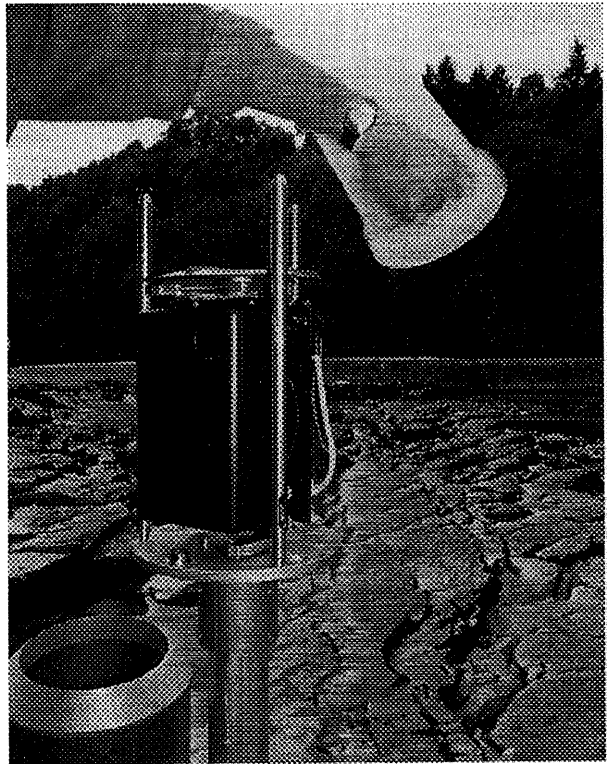

Evacuation of the balance tank

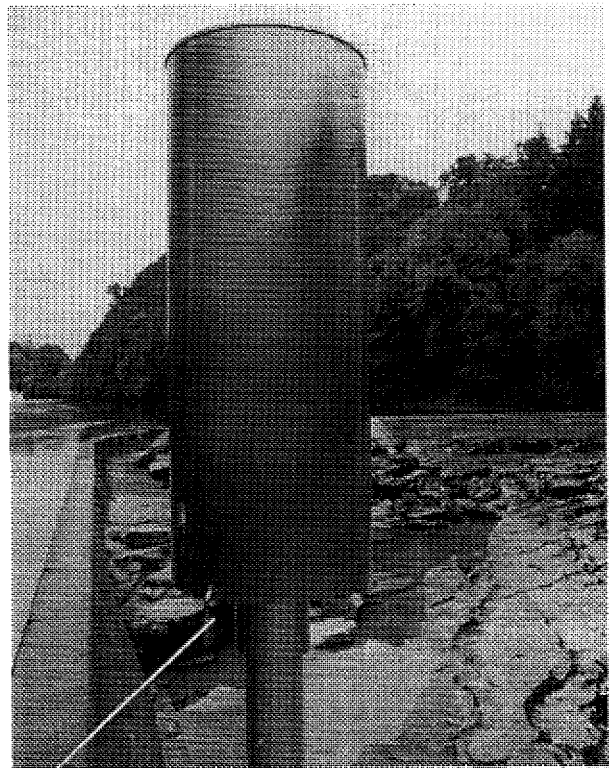

A padlock can be used to save the protective cylinder from unauthorised removal.

4.0 Designs

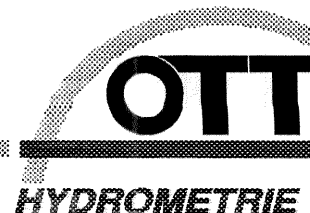

The collection area of the defining ring amounts to 200 cm².

The following measuring ranges are available:

Precipitation amount in mm	Measuring weight in kg	Resolution in mm
250	5	0.01
500 (in preparation)	10	0.02

The measuring range has to be adapted to the precipitation area and the observation intervals in question respectively.

The standard version of the device is equipped with the data logger OTT-LOG (128 KB) and an internal lead storage battery (6.5 Ah).

When **external data acquisition systems** are used, it can be beneficial to equip the raingauge with data logger and storage battery. In the event of power failure, data storage gaps in the series of measurements can thus be avoided.

As a price alternative, a version without data logger (pulse output) is available.

5.0 Standard device

5.1 Basic data-logging unit

The basic data-logging unit consists of the PLUVIO input/output card and the fastening material. The configuration of the OTT-LOG data logger has to be customised.

The optical interface is available with or without display. The display version is in preparation.

The PLUVIO input/output card requires a slot in the OTT-LOG data logger, but it is in a position to file several pulse outputs in the OTT-LOG memory.

Possible configurations:

Sensor number	Sensor type	Query interval, Storage interval	Free slots
Sensor #1	Precipitation intensity	1 minute	three
Sensor #2	evaporation intensity (in preparation)	10 minutes	two

Example of configuration - the OTT-LOG user matrix:

Precipitation intensity: Query and storage intervals

Query interval in min.	Storage interval in min.	Dimension of values stored	Time delay of values stored in min.	Accumul. capacity in days	Storage capacity <u>without</u> <u>with</u> storage delta	
Standard 1	1	mm/min.	4 - 5	50	35 days	> 1 year
1	5	mm/min.	6,5 - 7,5	50	175 days	> 1 year
1	10	mm/min.	9 - 10	50	350 days	> 1 year



Attention: Do not change the query interval! The query interval must always be 1 minute!

5.2 Measured values

Sensor #1 is standard, sensor #2 is available as **software option**.

Sensor #1: in plane 10 of the matrix two displays are possible: memory display and instantaneous-value display.

The **memory value** displays the precipitation intensity in mm per query interval (is automatically filled depending on the query interval chosen).

The **“precipitation Intensity in mm per query interval”** is the positive difference between two subsequent readings.

The **Instantaneous value** displays the precipitation amount in the balance tank (this value is only given for display purposes on an operating device or a PC for control measurement).

This signal is intended for control or calibration measurement only. Shocks during measurement are to be avoided since the display values are not filtered.

Due to the different tare and gross weights, the initial value has not been calibrated to zero. This value is to enable comparative measuring only.

When an operating device BG II is installed, plane 10 of the operating matrix displays the instantaneous value, i.e. the precipitation amount in the tank, which is updated approximately once every four seconds. During a query interval (is automatically run in the background, depending on the duration of the query) the instantaneous value is replaced by a storage value indicating the precipitation intensity.

The storage-value display either shows the current intensity or displays the error message “Error 02” (not ready) if the stainless protective housing has been opened → switching contact.

Example of a control or callbration measuring process:

- Remove the stainless protective tube (balance tank does not have to be emptied);
- Activate the operating matrix with the operating device BG II or a PC. → plane 10 (instantaneous value by sensor #1);
- Note down the initial reading of the tank contents once they have settled, e.g. 31.25 mm. The instantaneous value is not filtered so as to eliminate time delays. Avoid disturbing influences of wind and shocks as well as possible;
- Add 10 mm of precipitation by means of a graduated vessel (200 g, 200 cm³ or 0.2 L);
- Note down the final instantaneous value (if necessary re-activate the matrix), e.g. 41.30 mm
- Calculation of difference and error of measurement, e.g.
 actual difference: 41.30 - 31.25 mm = 10.05 mm
 set difference: = 10.00 mm

$$\text{Error of measurement} \quad \frac{\text{variance}}{\text{set value}} \times 100 = 0.5 \% \quad \frac{10.05 - 10.00 \text{ mm}}{10.00 \text{ mm}} \times 100 \% = 0.5 \%$$

Errors of measurement up to 1% are permissible;

- Empty the tank;
- End the test;

The **“evaporation Intensity in mm per query interval”** is the negative difference between two subsequent readings (in preparation).

5.3 Time delay of precipitation intensity stored

The filtering of the measured values (because of wind influences) causes a signal delay. The mean time delay is 4 to 5 query intervals, which means that a precipitation event is only filed in the memory with a delay of 4 to five query intervals.

Short-time precipitation events (< 1 minute) are not lost since the precipitation amount which the calculation of precipitation intensity is based on remains within the balance tank.

In connection with the relevant input cards the OTT-LOG data logger can optionally be equipped with **additional sensors** such as **PT 100** or **Humidity**. A maximum of four sensors, e.g. for precipitation intensity, evaporation intensity, air temperature and air humidity, can be connected to the data logger.

The configuration of operation modes such as **delta storage** (standard) and **speech output** (in connection with a HYDROSENS system) is possible.

Alarm signal output for high-water advance warning stations is in preparation.

In addition to the above-mentioned sensors the input/output card provides an **pulse output**. Load independent current is provided on the OTT-LOG sensor plug for this purpose. After the measured-value query the pulses are emitted at a frequency of 500 Hz. Consequently, the length of both pulse duration and interpulse period is 1 ms each. During pulse generation the current flow amounts to approximately 20 mA (short-circuit proof), in interpulse periods the output has high impedance. Electrical isolation is possible. One pulse corresponds to 0.01 mm of precipitation.

5.4 Basic pulse-output unit

A version for external data acquisition systems is available as an alternative for the standard version with data logger. This version encompasses the complete weighing system (standard device) and a printed circuit board for pulse output with integral evaluation electronics.

Electrically isolated contacts and power sources are available for the output.

After the measured-value query the pulses are emitted at a frequency of 25 Hz. Consequently the length of both pulse duration and interpulse period is 20 ms each. Electrical isolation is possible.

On separate connectors two different resolution levels are possible:

- One pulse corresponds to 0.01 mm
- One pulse corresponds to 0.1 mm

Moreover, two different types of output wiring have been realised:

- Electrically isolated contact (make contact)
- Source of electricity (load independent current 20 mA)

6.0 Electric power supply

The standard version of every rain gauge is equipped with a **12 V lead storage battery**. The disposable ampere-hour capacity is 6.5 Ah. The current consumption of the active device is 60 mA.

The ampere-hour capacity of 6.5 Ah allows for the operation of the device for 50 days with one query per minute. For recharging purposes the storage battery can be removed from the rain gauge.

When external power supply is used the following data have to be observed:

Direct current voltage, equalised 12 V (8 - 16 V); 100 mA (max.)

Changing the storage battery

To change the storage battery unscrew the plug adapter and lift the battery to remove it laterally to the right.

The voltage of the storage battery can be tested (ampere-hour capacity test) with plate 02 of the OTT-LOG operating matrix (operating device BG II or laptop with OMS matrix software or HYDRAS II software respectively).

```
02 BATTERY 10.3V  
CONSUMP. 00.123AH  
CHANGE 12.02.90
```

Please exchange the storage battery if voltage drops below 10 V.

The approximate consumption very roughly displays the ampere-hour capacity consumed so far. Faultless measurements can be taken down to a voltage of about 8 V.

Please press the ENTER key in plate number 02 of the of the OTT-LOG operating matrix so as to confirm the exchange of the storage battery. The display will be reset.

Storage battery 12 V, 6.5 Ah - Standard dimensions: length 151 mm x depth 65 mm x height 105 mm.

When other storage batteries are used, length and height may each be exceeded by approximately 10 mm. The depth must not exceed 65 mm.

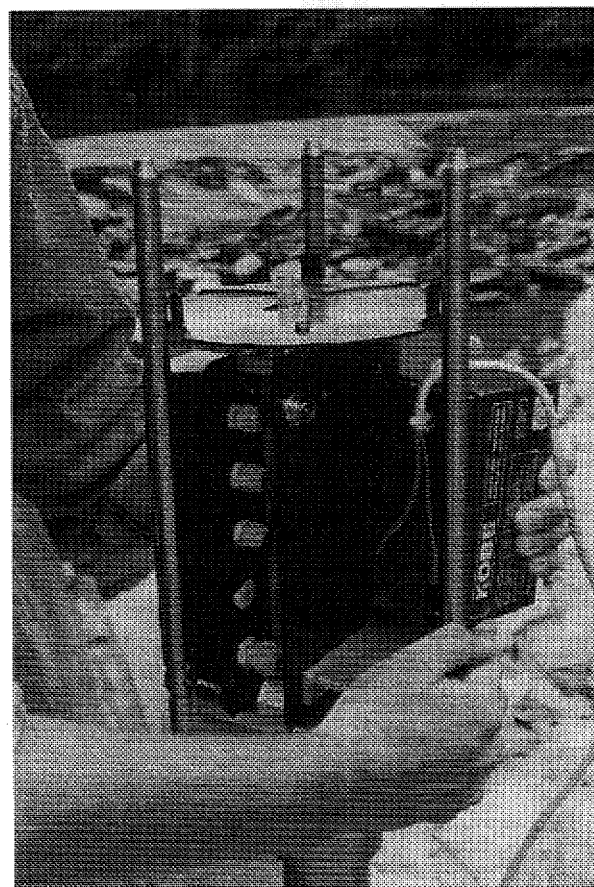
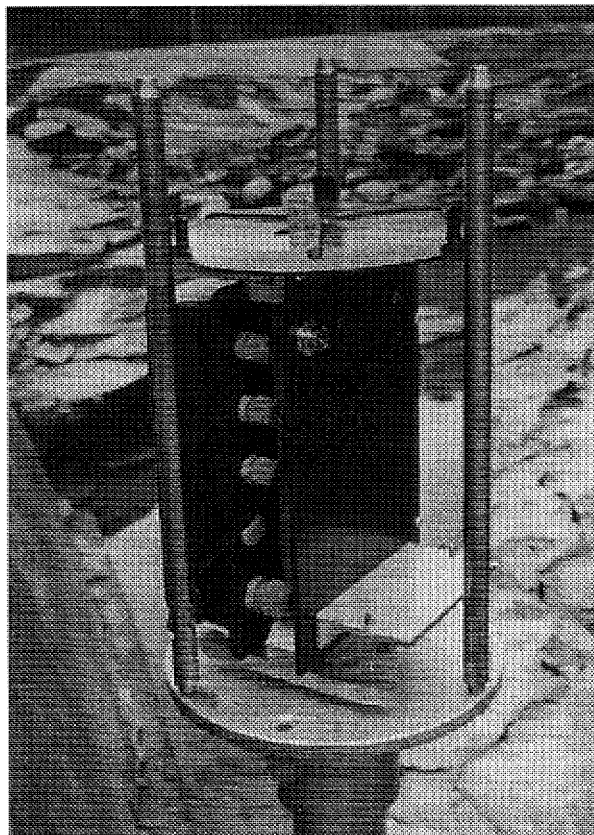

Electric power supply

For use of other storage batteries a connecting cable is available (included in the set of cables 70.010.030.3.2) please observe the above-mentioned battery dimensions.

Distribution voltage loss (power failure)

During power failure no measurements are taken and no signals are emitted. However, the weight of the balance tank that was last measured will be stored in the evaluation electronics.

When measuring is resumed the new weight of the tank is acquired. The change over the previous measured value will then be transmitted with a short delay caused by measured-value filtering.

This means that any precipitation that is collected in the balance tank during power failure is not lost but rather transmitted immediately afterwards.



7.0 Pin configuration in the case of external power supply

When an external power supply or the CAN bus connection are used a lightning-protection unit is included in the regular equipment.

The internal connections have already been prepared and the external mains cable can be lead upwards through the base plate.

Mains cable (e.g. underground cable):
 2 x twin-core cable, stranded in pairs
 Cross section: 0.75 - 1 mm²
 Specific resistance: < 26 ohms/km
 Impedance level: 80-150 ohms
 Length: 1 km (max.)

Preferably, the cable should be laid within the stand tube. We recommend dismantling the cable already at the upper end of the tube and to provide protective sheathing for the four remaining leads and to pass them upwards into the PLUVIO (cf. fig.).

The lightning-protection modules eliminate the excess voltage via an earth contact. So as to assure a high degree of protection the PLUVIO must be connected via a short cable (cross section 10 mm²) to a reliable earth connection.

Connecting the raingauge (cf. Figure):

- 1) Remove motion rod with a 5 mm Allen key.
- 2) Unscrew the right-hand housing cover.
- 3) Item 3 shows the lightning-protection modules.
- 4) Lead the mains cable upwards through the stand tube (5) and dismantle it at the upper end of the tube. Equip the individual leads with protective sheathing and carefully pass it through. **The aluminium profile (position 6) and the threaded rod must not be exposed to any major shocks or strains nor actuated excessively.** Put PLUVIO onto the stand tube. For orientation and locking of the raingauge cf. section "Installation" above.
- 7) Connect to mains supply.
- 8) Screw the earth connection to the bottom side of the base plate. Re-mount motion rod (1) and housing cover (2).

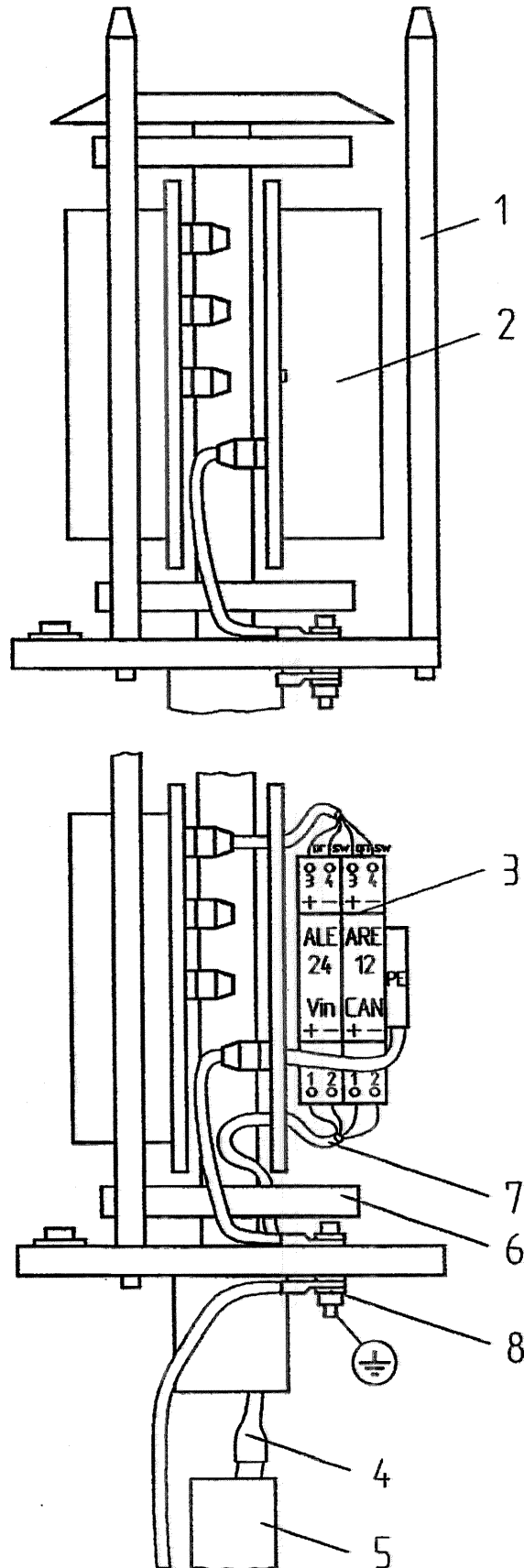

Pin configuration in the case of external power supply

7.1 Stand tube

A 2" tube (60 mm in diameter) that is 800 mm long was chosen for the stand tube. For reasons of shock-proofness it is of robust design. The tube should be encased with concrete so as to assure stability.

The upper end of the tube is blank and unworked (no thread, no bore holes). The clampable diameter range is between 55 and 65 mm.

The upper edge of the tube must be 570 mm below the desired installation level.

Example:

Opening of balance tank:
1 m above ground level;

Upper edge of tube:
430 mm above ground level.

Please indicate if you require customised tube length.

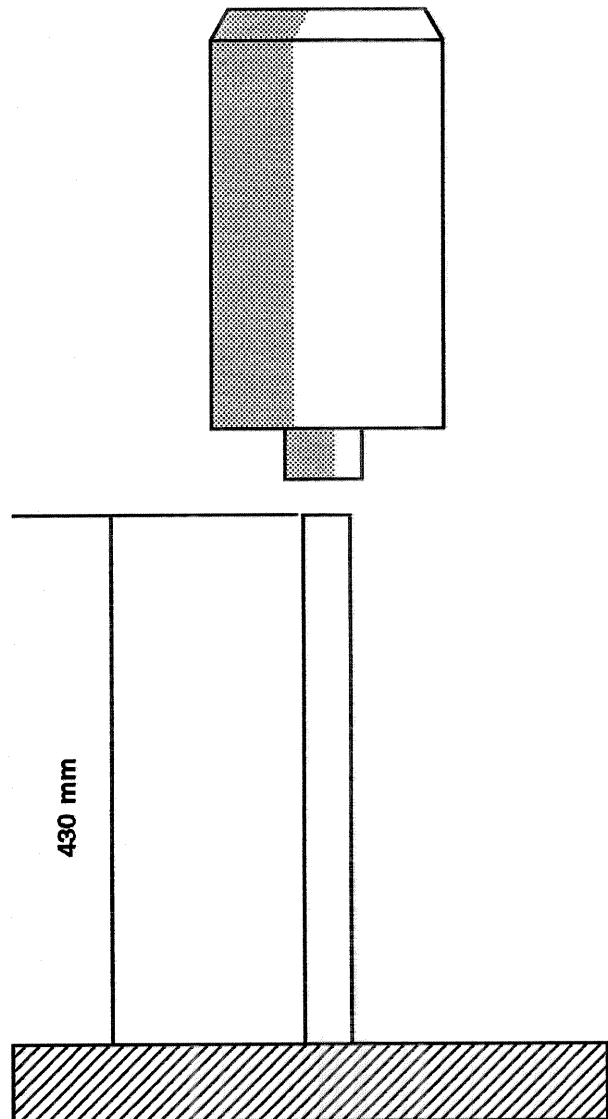

8.0 Data reading

The measured values are read out by the data reading unit HYDRAM II via the optical interface either onto a memory card or directly into a laptop. The measured values are evaluated by means of the OTT software HYDRAS II.

8.1 Data reading with the HYDRAM II

Please connect the HYDRAM II reading unit via connecting cable (optical reader head) with the optical interface (PLUVIO). Please insert the memory card in the back of the HYDRAM II.

The HYDRAM II is switched on with the yellow button. The following display appears:

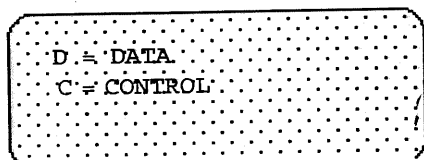

D = for data transfer
C = control function of value, time, date

After pressing the yellow button again, the display shows:

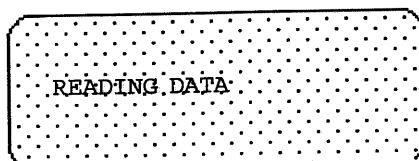

The data transfer from the PLUVIO onto the memory card is now active.

After a acoustic signal 'BEEP, BEEP' the display shows

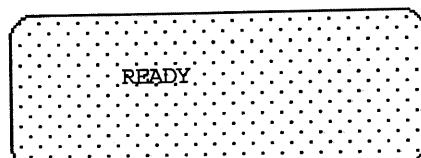

For more informations about data transfer data logger <-> HYDRAM or HYDRAM <-> PC see HYDRAM II / HYDRAS II manual.

Instead of the HYDRAM II the data readout is possible directly into a laptop/PC in combination with the user software KH II or HYDRAS II.

Use connecting cable with optical reading head 55.500.090.3.2 and adapting cable 55.500.089.3.2 - see page 20 -

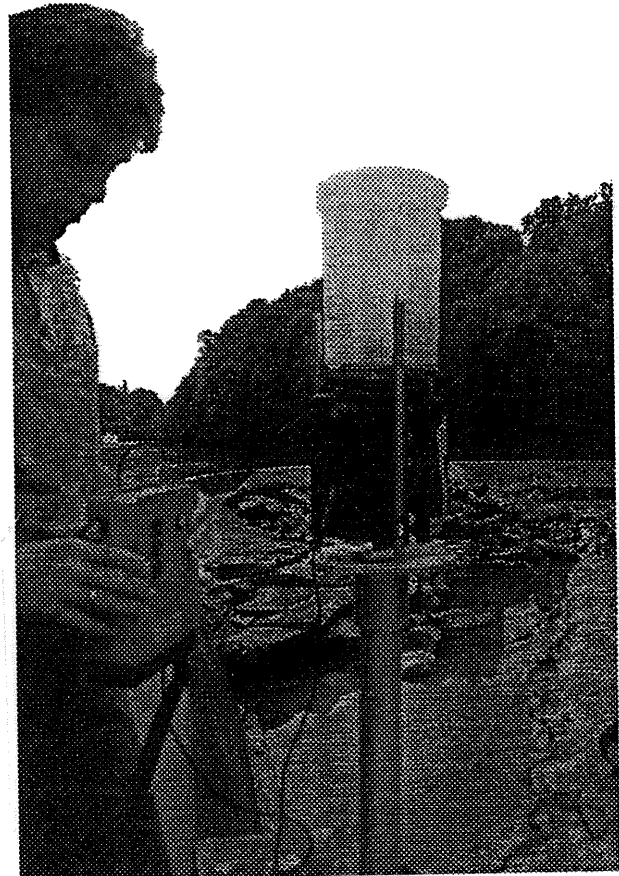

9.0 Parametrierung

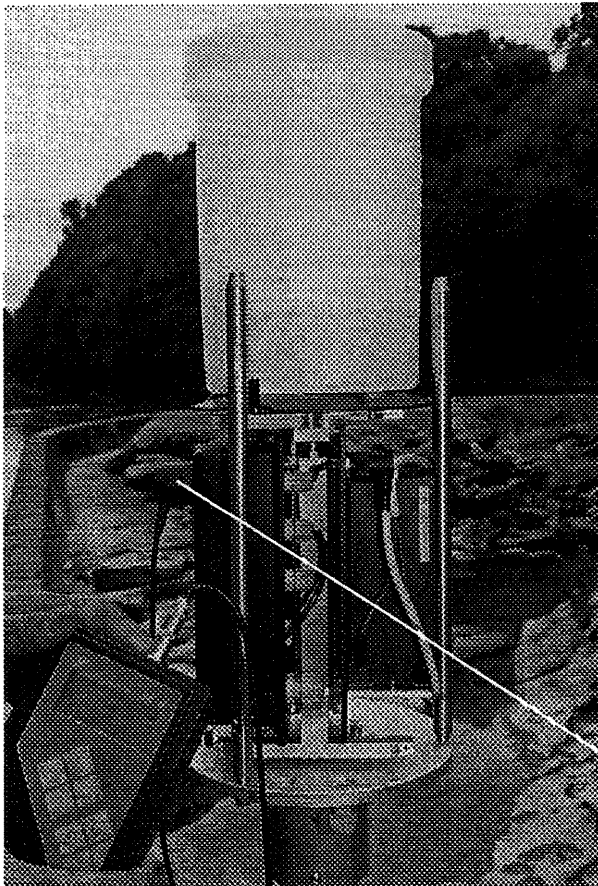

Data-logger parameterization with operating device BG II

The operating device BG II is connected to the optical interface of the OTT-LOG data logger via the optical reading head.

Query and storage intervals, delta storage, etc. can be set by the integrated matrix software.

State of the battery, instantaneous value, time, etc. can be controlled the same way.

Apart from the operating device BG II, a laptop or PC and the OMS matrix software or HYDRAS II software can be used to influence the above-mentioned functions.

The measured values are read out via the optical interface either by the data reading unit HYDRAM II or a laptop or PC.

Optical interface

10.0 OTT-LOG Pin configuration

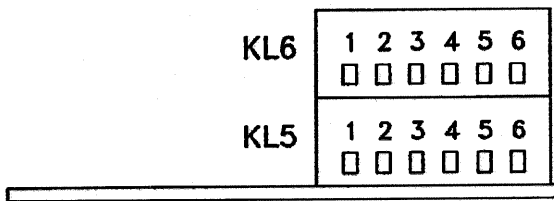
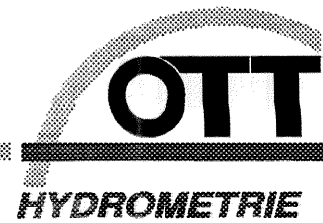

CL6	Lead colour	Description
1		
2		
3		
4		
5	white	CAN high
6	brown	CAN low

CL4	Lead colour	Description
1		
2		
3		
4		
5	blue	GND
6	red	Vin (+12V)

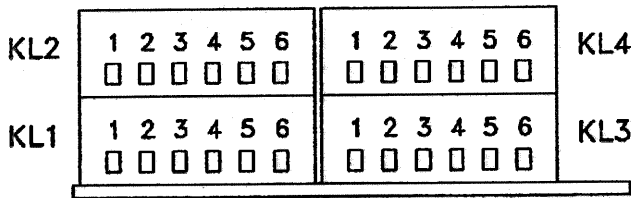

CL1	Lead colour	Description
1	green	Pulse Vin
2	yellow	Pulse Out +
3	grey	Pulse Out -
4	pink	Pulse GND
5		housing contact
6		housing contact

Example: pulse-output connection

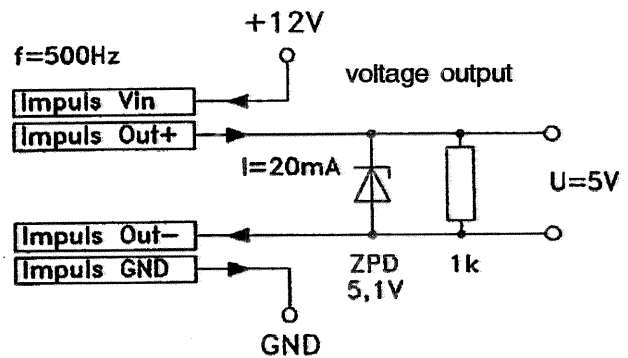
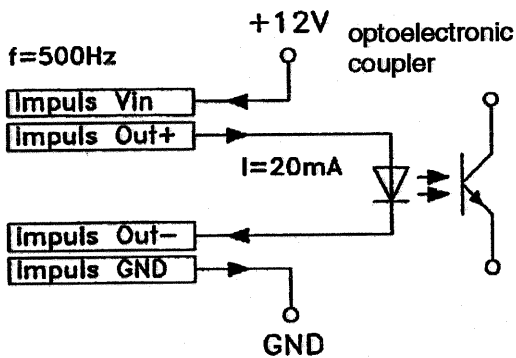

Overview

Parameterization with operating device BG II or laptop

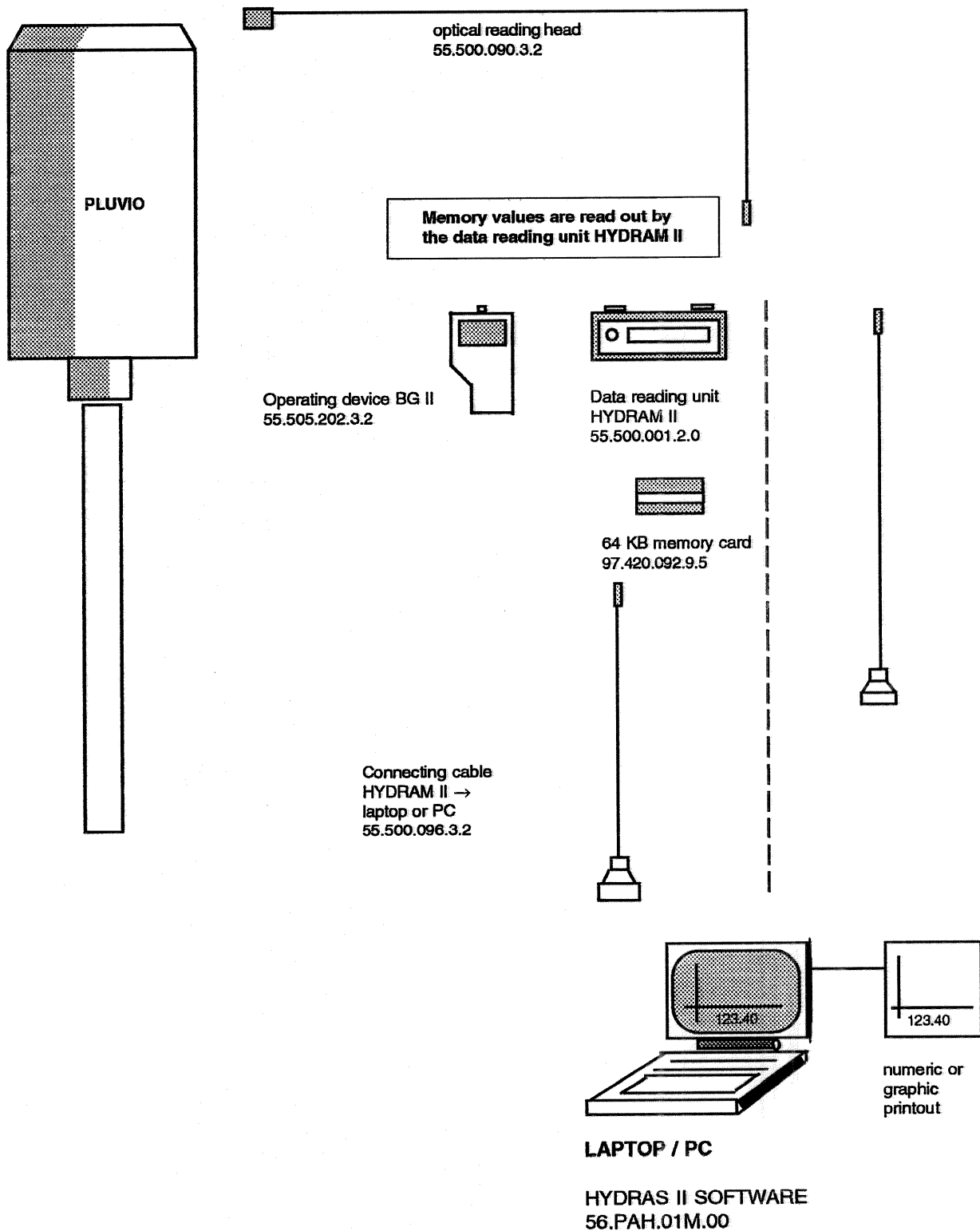

Titel: PLUVIO
Bezeichnung: Operating instructions
Zeichnungsnummer: 70.010.000.B.D

Ersteller: M. Dittrich

Datei: PLUVI-BE.PM5

Letzte Fassung (extern): –

Letzte Fassung (intern): –

Aktuelle Fassung: 08.03.1995

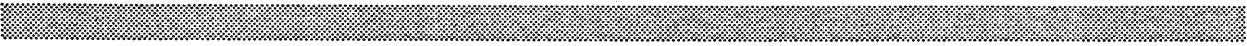

OTT MESSTECHNIK GmbH & Co. KG

**Ludwigstraße 16
87437 Kempten**

**Tel: 0831/5617-0
Fax: 0831/5617-209**

PLUVIO precipitation gauge Maintenance instructions

Contents

- 1 Maintenance work
- 2 Winter operation
- 3 Service intervals
- 4 Replacement parts
- 5 Measurement test
- 6 Calibration
- 7 Changing the software
- 8 Guarantee

1 PLUVIO - Maintenance work

- **Empty the collection tank.**

The tank must be emptied after a long period of rainfall to prevent it from overflowing. The intervals at which the tank are emptied depend on the local conditions. The contents can be emptied at any time regardless of the level. When the housing is open, the limit switch fitted at the side prevents faulty signals caused by moving the tank. After the device is closed and a safety time period of three minutes, the new tank weight is automatically calibrated.

- **Visual inspection:**

Check that the collection tank clears the bottom edge of the collection opening. To do this, move the tank by briefly touching it from the side when the pipe housing is closed. The upper edge of the tank must not touch the housing. Minor movements do not generate incorrect precipitation signals.

Clear away any heavy build-up of dirt or ice.

Remove any insects or insect nests.

The micro limit switch (on the side of the device) must be audible when switched. In addition, the metal bracket must actuate the switch when the housing is closed.

- The service life of the power battery (12V; 6.5Ah) is approx. 2 months. Replace the empty battery (< 10.5V) and recharge it outside the device.

- **Check the following if a malfunction occurs, as well as carrying out the visual inspection:**

Is the tank deformed?

Is the tank securely mounted on the three-point black support?

Is the stainless steel pipe housing incorrectly fitted or damaged?

Does the moving part in the weighing mechanism stand clear of the stationary parts?

Are the transverse handle bars (2mm metal rods) at the top and bottom of the device deformed?

Is there any contact between the moving part of the weighing mechanism and a supply cable?

- Conduct a measurement test as described below.

2 Winter operation

- At negative temperatures, fill the tank with a **saline solution**. The saline solution allows snow which has collected in the tank to melt and prevents the base of tank from being severely deformed if the precipitation freezes (temperatures under -10°C, 14°F). Ordinary household salt can be used. The mix ratio may vary between 1:2 and 1:5 depending on the frost temperature. Open the device to fill it.

Example, temperature -15°C, 5°F: Stir together 1 part salt and 3 parts water,
approx. 1 litre in total (5cm water level).

- **Remove any accumulated snow or ice from the collection opening at the top.**

3 Service intervals

- **Battery change,**
PLUVIO with OTT-LOG: every 2 months
PLUVIO with pulse output: every 4 months

- **Emptying,** 250mm type: 1 to 4 times a year
(more frequently in areas of high precipitation)
- 1,000mm type: Once a year
(more frequently in areas of high precipitation)
- **Visual inspection:** Once a year
- **Measurement test** Once a year

4 Replacement parts

The following replacement parts can be ordered using the numbers listed below.
All of these parts can be replaced on site by the operator.

- Pipe housing 250mm type, 200cm² 70.010.040.3.2
- 1,000mm type, 200cm² 70.010.238.3.1
- Tank 250mm type 70.010.000.3.5
- 1,000mm type 70.010.200.3.5
- 12V battery; 6.5Ah 96.820.024.9.5
- Connector cable for battery 70.010.031.3.2
- Bird protection ring Type 250mm, 200cm² 70.010.060.4.2
- Device flanged panel plug, 6-pin, pins 96.120.446.9.5
- Cable plug coupling, 6-pin, sockets 96.120.447.9.5

5 Measurement test

Check the weight measurement by carrying out a measurement test.

Example of carrying out a measurement test on a PLUVIO with data logger OTT-LOG:

- Take off the stainless steel pipe housing (do not empty the tank).
- Activate the operator matrix with either the BG II control unit or the PC. Field 10 (instant value sensor 1)
- Make a note of the initial instant value of the tank quantity when steady, e.g. 41.25mm.
The instant value is not filtered, in order to avoid delay times. Try to prevent wind or vibration from affecting the measurement.
- Use a measuring container to add 10mm of precipitation (200g, 200ccm, 0.2l produce 10mm with a collecting surface of 200cm²).
- Make a note of the end instant value (restart the operator matrix, if necessary)
e.g. 51.35mm

Calculation example of the difference and the measuring error:

Actual difference	51.35 - 41.25mm	= 10.10mm
Target difference		= 10.00mm

$$\text{Measuring error} = \frac{(\text{Actual} - \text{Target})}{\text{Target}} \times 100 = \text{Error} [\%]$$

$$(10.10 - 10.00 \text{ mm}) / 10.00\text{mm} \times 100 = 1\%$$

- Empty the tank.
- End the test.

Checking the stored or pulse output values

- Close the pipe housing or actuate the micro limit switch (on the side of the device).
- Wait for at least 5 minutes before filling the tank with a test quantity (water or weight).
- After another at least 8 minutes, read the data logger or pulse counter (with debouncer) and compare the total with the test quantity. Due to the software filter, the precipitation is indicated as several partial values at minute intervals. Add these partial values to get the total quantity. This can now be compared with the test quantity.

6 Calibration

The weighing system only needs to be recalibrated if several measurement tests consistently yield incorrect results (avoid wind and rapid fluctuations in temperature). In general, incorrect calibration values are caused by damage to the weighing system.

7 Changing the software

New PLUVIO software versions can be transferred by means of a laptop and a suitable interface adapter. Versions after PLU_LOG.V04 (with data logger) and PLU_IMP.V02 (pulse output) do not need to be recalibrated before being replaced. OTT-LOG software can be replaced using an EPROM module.

8 Guarantee

The guarantee period for material defects is 6 months. More information on the terms of guarantee is included in the "General Terms and Conditions" (see OTT product overview, appendix).

Tank as additional measurement sensor

The PLUVIO tank quantity indicates the total amount of precipitation found in the collection tank. This sensor is only available **together with the data logger version of the PLUVIO** (not for devices with pulse output).

The quantity of precipitation and **evaporation** can be determined with the signal form of the tank. The evaporation values measured can vary from the real evaporation values because of the shape of the housing and the level.

The basis for calculation is the **virtual formula sensor** in the HYDRAS2 evaluation program from OTT.

The tank can be activated as sensor 2 on the OTT-LOG. This applies to all PLUVIO devices sold to date and all software versions. A **jumper** is fitted on the OTT-LOG for enabling the sensor (see drawing).

In this way, the OTT-LOG can activate the tank (PLU-SUM), which is the second sensor, via the first slot (precipitation intensity PLU-INT) from the PLUVIO input card. When the PLUVIO pipe housing is open, **Fault 02** appears.

Since July 1997, all PLUVIO data logger devices are factory-fitted with the tank.

The following matrix settings are recommended for the OTT-LOG:

Valid for OTT-LOG software versions up to V2.10

Sensor no.1

10 SENSOR 1 PLU-INT No.0001 TYPE Intensity 45.30 mm	11 MIN: 00:01:00 0.00 mm MAX: 10:31:00 0.15 mm	13 INTERVALS SAMPLE 00:01:00 STORAGE 00:01:00	14 STORAGE DELTA 0.00 mm STORE WITH TIME NO	15 SCALING (100% 100.00) (0% 0.00) POINT POS xxx.xx
---	---	---	--	---

Sensor no.2

20 SENSOR 2 PLU-SUM No.0002 TYPE Tank 45.30 mm	21 MIN: 00:10:00 40.17 mm MAX: 11:30:00 45.30 mm	23 INTERVALS SAMPLE 00:01:00 STORAGE 00:10:00	24 STORAGE DELTA 0.00 mm STORE WITH TIME NO	25 SCALING POINT POS xxx.xx
--	---	---	--	--------------------------------

As of software V2.11, the matrix setting is as follows:

Sensor no.1

10 SENSOR 1 PLU-INT No.0001 TYPE Intensity 45.30 mm	11 TOTAL DAY 5.13 DAYBEFORE 3.46 2 VISITS 23.12	13 INTERVALS SAMPLE 00:01:00 STORAGE 00:01:00	14 STORAGE STORE ZERO NO STORE WITH TIME YES	15 SCALING SCALING FACTOR 0.01 POINT POS xxx.xx
---	--	---	---	--

Sensor no.2

20 SENSOR 2 PLU-SUM No.0002 TYPE Tank 45.30 mm	21 MIN: 00:10:00 40.17 mm MAX: 11:30:00 45.30 mm	23 INTERVALS SAMPLE 00:01:00 STORAGE 00:10:00	24 STORAGE DELTA 0.00 mm STORE WITH TIME NO	25 SCALING POINT POS xxx.xx
--	---	---	--	--------------------------------

OTT-LOG jumper for enabling the tank

An 8-pin socket connector with 2 diodes and 2 short-circuit jumpers are required for converting the data logger (ST2 and ST3).

The data logger is located behind the black plastic cover with the optical interface. Open this cover using a small Philips hand screwdriver.

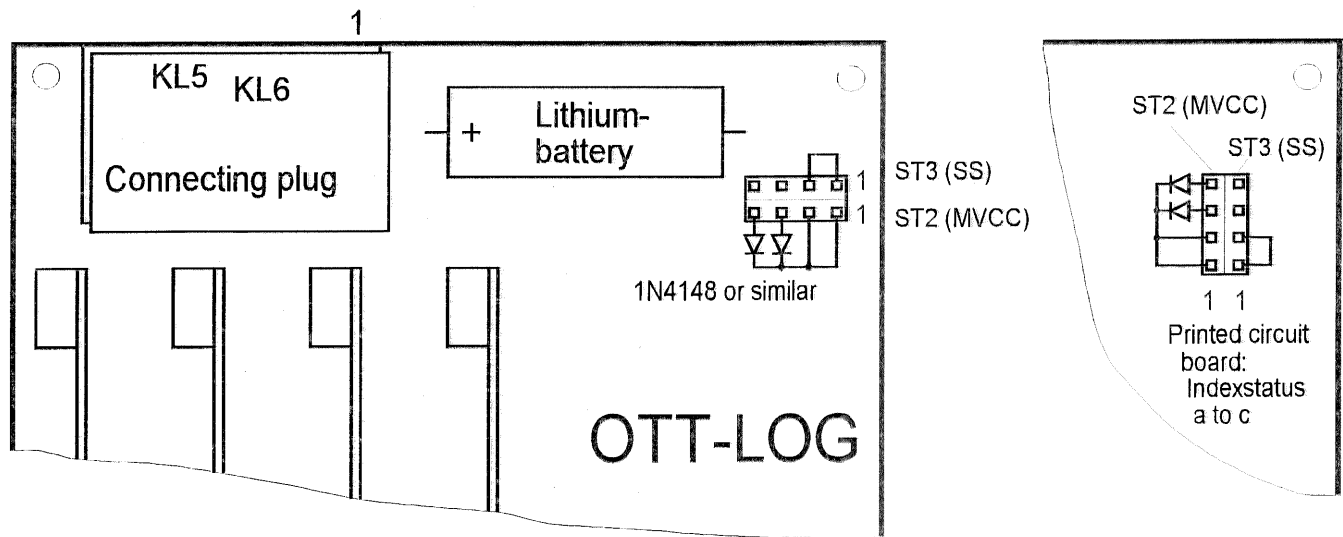

Initializing the additional sensor in the OTT-LOG data logger

Activate the OTT-LOG matrix field with the control unit or the PC.

Enter code 59 in field 70 and then activate the new sensor in field 72.

70 SENSOR CONFIG	
CODE	59

72 INIT. SENSORS	
INSTALL ANEW ALL	
S. NEWLY PLUGGED	

From now on, line 20 appears in the matrix field.

Other input cards can be inserted in **slots 3 and 4** as desired.

The following equipment is necessary for subsequent conversion of the additional sensor:

- Hexagon spanner 5mm (Allan key; for dismantling one of the aluminium guide rods, if needed)
- Small cross-head screwdriver
- Medium slotted screwdriver, (for dismantling the printed circuit board for the optical interface, if needed)
- Pincers or pointed pliers
- Jumper (see drawing)
- Control unit or laptop

Virtual sensor in HYDRAS2 evaluation program from OTT

It is possible to calculate the total amount of precipitation or evaporation using the signal form of the tank with the HYDRAS2 virtual formula sensor and to save this as a new measuring sensor under the same station number in the database.

Example of creating an evaporation sensor

Data management --> Virtual sensor --> Formula calculation --> (Select station)

Calculation of formula						
	<u>Y0:=X1 X0:=X1</u>					(X is the source sensor, tank sensor 0002) (Y is the target sensor to be calculated, evaporation sensor VV02)
	Y:= X0 - X1					(Previous tank value X0 minus new tank value X1; sensor 0002 = Reduction in weight, evaporation)
IF	Y < 0	Y:= 0				(If difference Y is smaller than zero, then no evaporation.)
IF	Y > 2	Y:= 0				(If difference Y is greater than 2mm, probably emptied manually) (Y is set to zero under these IF-conditions.)
Station / Sensor	I	T	Time displacement		Target sensor (Y)	
X1 0000132100 / 0002	v		0h 0m	Text	Virt. Evaporation	
X2 0000000000 / 0000	v		0h 0m	Number	VV02	
X3 0000000000 / 0000	v		0h 0m	Unit	mm	
X4 0000000000 / 0000	v		0h 0m	Database		
X5 0000000000 / 0000	v		0h 0m	Database type	N	
X6 0000000000 / 0000	v		0h 0m	Storage int.	(10min)	
Y0:=0				Post-pt. dig.	xxx.xx	

Now calculate sensor number **VV02** of the station 132100:

Calculating of a Virtual Sensor...

...

Processing of a single sensor

The **evaporation intensity** (reduction of weight in collection tank) is now saved under the sensor number **VV02** in mm every 10 minutes. The daily totals can be calculated from these values (*Evaluate --> Daily values*).